

# Wardrobe Sliding & Folding Door Systems

## MI-689 MOBILE Wardrobe Sliding System for 2 & 3 Doors (with soft close)

Track Length : 2000mm, 3000mm

### Features:

- Easy Installation
- With top & bottom synchronised dampers
- With anti derail functions
- Door Thickness : 18 - 46mm
- Load Capacity : Max. 80kgs / Panel



Double soft close for 2 doors

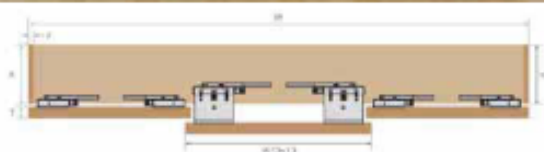

Full soft close for 3 doors

## MI-SL0798 In Line Sliding Door System

Track Length : 1800mm, 2000mm, 2400mm, 3000mm



### Features:

- The cabinet door is flushed when closed.
- Two way soft closing.
- The cabinet door up and down, left and right gaps are adjustable.
- Door panel thickness : 18mm - 45mm
- Loading capacity : Max : 60kgs / panel

Train wheel and accessories: steel / engineering plastic.  
Track: Alluminium Alloy.



# Wardrobe Sliding & Folding Door Systems

## MI-SL0509-2/3 Wardrobe Sliding Door System with Soft Closing



2 Door Fittings

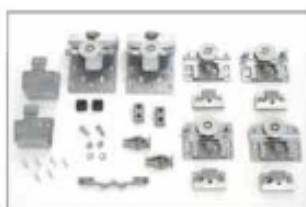

3 Door Fittings



Soft Closing Damper

**Notes:**

1. Rail Length : 2000mm, 3000mm
2. Door Thickness : 20 - 25mm
3. Door Weight : 20 - 50kgs / Panel

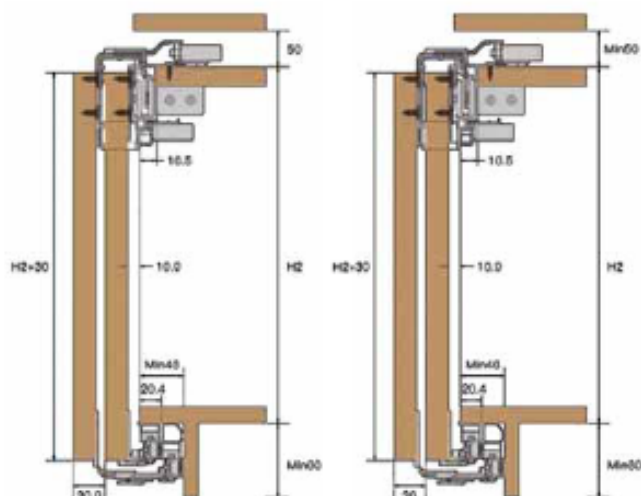

## MI-0301008 Inner Hanging Fold Sliding Door Fittings

Sliding door fittings: steel / plastic  
Rail: aluminium (silver coloured anodized)

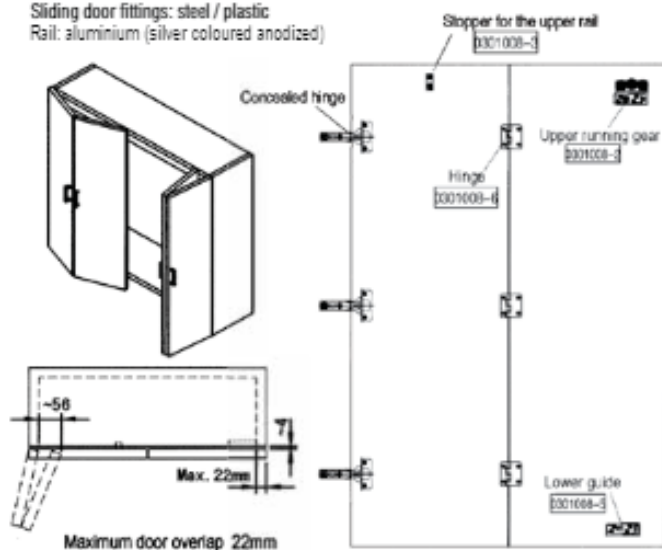

# Wardrobe Sliding & Folding Door Systems

## MI-SL0802 In Line Flush Sliding System For Lower / Hanging Cabinet

### Hanging Cabinet Installation

X=Top panel thickness E=Thickness of door panel cover bottom panel

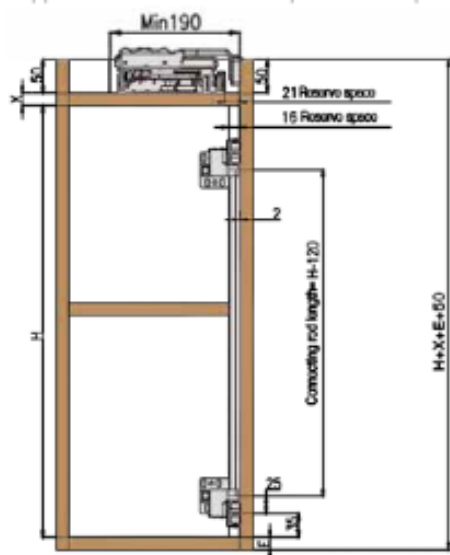

### Product Specification

Cabinet Inner Width	Cuttable Rail Range	Door Width (door panel cover side panel 26mm)	Door Height
1750mm	1150mm - 750mm	600mm - 900mm	≤1000mm
2350mm	1750mm - 2350mm	900mm - 1200mm	≤1500mm

## TANGO 40-150 Manton Partition Doors And Wardrobe Doors

Made in France

### Folding system TANGO® up to 40 Kg per Panel

**FLEXIBLE:**  
for partition doors or for wardrobe doors 2 or 4 panels

**DESIGN:**  
No lower track and minimum gaps



# Wardrobe Sliding & Folding Door Systems



**MI-9512**  
Stainless Steel Cabinet Roller Set  
Track : ZY328



**ZY-293**  
Cabinet Roller Set  
Track : ZY328

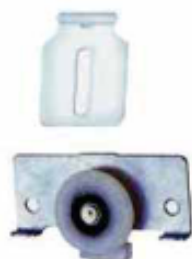

**M-688**  
Adjustable Top & Bottom  
Roller Set (40kg)  
Track : M880-1/2



**ZY-328**  
3 meters Track  
Top & Bottom Track



a) M-680-1  
3.7 meters Single Track  
b) M-680-2  
3.7 meters Double Track

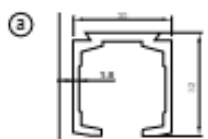

a) MI-TM1305  
Aluminium Track  
2 meters, 2.5 meters, 3 meters, 5 meters  
b) M-857  
Sliding Door Roller Set  
Load Capacity : 130kgs

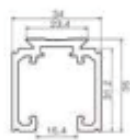

**MI-SL-09048**  
2 Way Soft Closing Sliding Gear  
with 2500mm Track  
Load Capacity : 100kgs  
Door Thickness : 35-50mm  
Min. Door Width : 820mm



**DF-01**  
Sliding Door Stabilizer  
(For Doors Up till 2500mm)



**BF 05** Soft Closing Damper For  
Drawer And Sliding Door

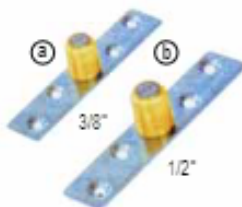

a) M-289 b) M-287  
Brass Roller Guide



**M-288**  
L Roller Guide