

# LIFT-ASSIST DAMPER



LAD



### ■ Features

- Lift-assist mechanism with light opening.
- Smooth and soft close movement at the end, preventing flaps from slamming shut.
- Ideal for counter flaps at bars, restaurants, and receptions.
- Door thickness: 15~25 mm. Max. door thickness with spacer LAD-DP is 40 mm.
- Can be installed on the backside of a table with bracket.
- Successfully passed for the 100,000 open/close private cycle test.

### ■ Parts Included

Binding head tapping screw 4×16

### ■ Application Example

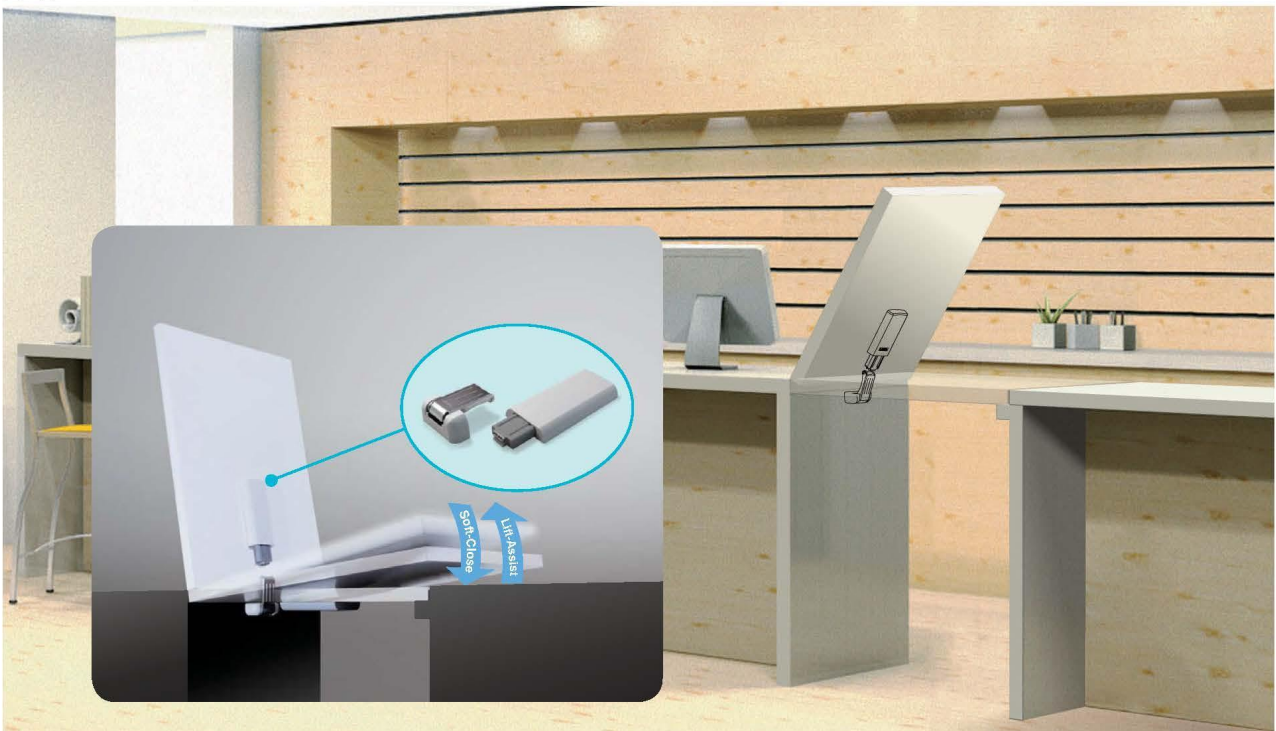

### Lift-Assist

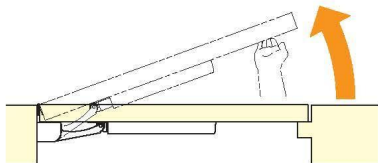

### Soft-Close

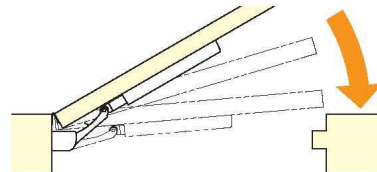

### ■ Installation Position for 2 pcs

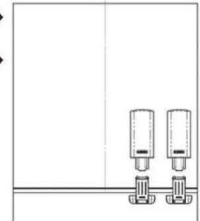
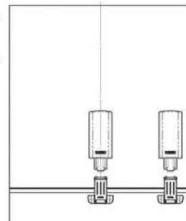
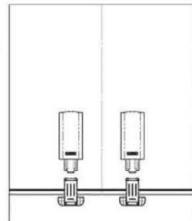
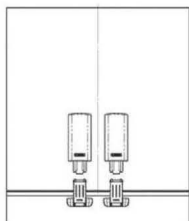

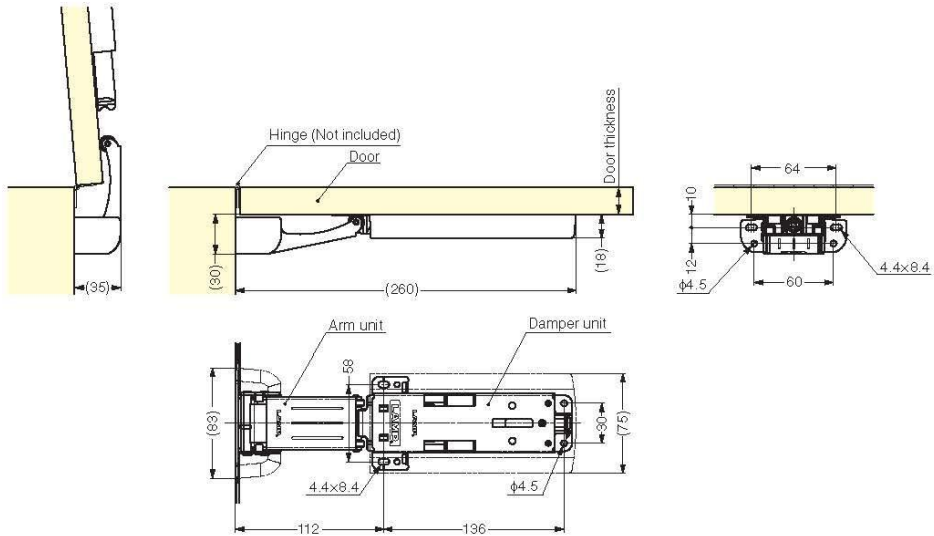

**Door Size Ranges: 1 pc Use (※2 pcs use possible. Torque moment becomes double.)**

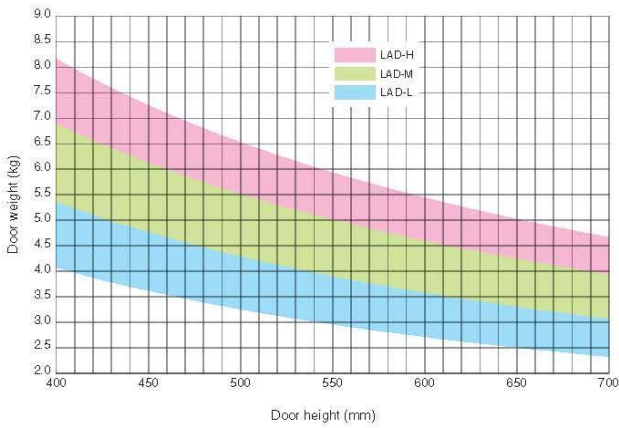

Item Code	Item Name	Material	Finish	Torque Moment/piece	Door Thickness	Weight	Carton
170-025-804	LAD-L	ABS/ Polyacetal (POM)/ Steel	Zincing/Nickel Chrome	8.0~10.5 N·m ( 81.6~107.1 kgf·cm)	15~25	545 g	20 pcs
170-025-805	LAD-M			10.5~13.5 N·m (107.1~137.7 kgf·cm)		568 g	
170-025-806	LAD-H			13.5~16.0 N·m (137.7~163.2 kgf·cm)		571 g	

## SPACER

For over 25 mm thickness door.

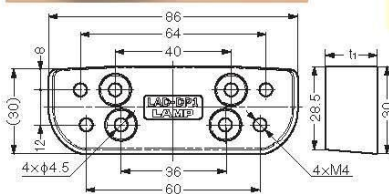
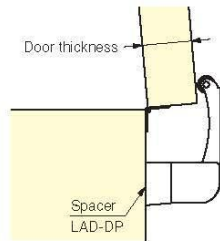

Item Code	Item Name	t <sub>1</sub>	Door Thickness	Material	Colour
170-028-234	LAD-DP1	18	25~35	Polyacetal (POM)	Grey
170-028-235	LAD-DP2	25	30~40		

## LAD-DP

## BRACKET FOR BACK MOUNT

## LAD-BKT

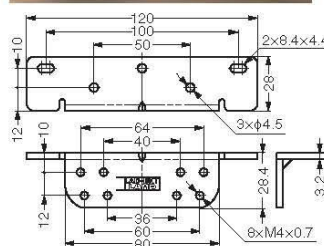
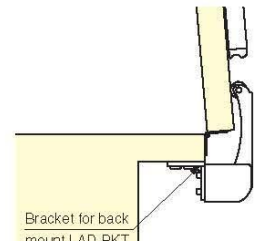

Item Code	Item Name	Material	Colour
170-028-236	LAD-BKT	Steel (SPCC)	Nickel